

Logger, Transmitter & Controller





GrowControl PHX and PHX+ are precision digital sensor transmitters for temperature and pH, plus optional ORP. Color LCD display and button interface model allows instant access to sensor readings, guided calibration, alarms, historical graphing and more.

Connects to Agrowtek's GrowControl Cultivation Controllers as part of a complete facility control solution. LX2 ModLINK connects GrowNET™ devices to RS-422/485 for MODBUS RTU protocol.







Internal memory logs over 20,000 data points per sensor. Available with WiFi module for remote monitoring, data logging, alerts, and more. LX1 USB AgrowLink connects the GrowNET port to a PC for datalog download to .csv, graphing, calibration, configuration, updates, etc. using free PC software.



Sensors

-  Water Temperature
-20 - 60°C x 0.1°
-  pH
0 - 14pH x 0.01pH
-  Color LCD display for sensor monitoring & graphing *optional*
-  Real Time Clock (RTC)
Battery Backup Included

Features

-  WiFi optional for sensor monitoring
-  GrowNET™ port for connection to AgrowDose Pumps, LX1 USB link or LX2 ModLINK
-  MODBUS RTU for industrial PLC applications
Available 4-20mA analog outputs
-  Durable splash-proof ABS plastic enclosure
Conformal coated circuit boards
-  1-Year Warranty
-  Made in USA

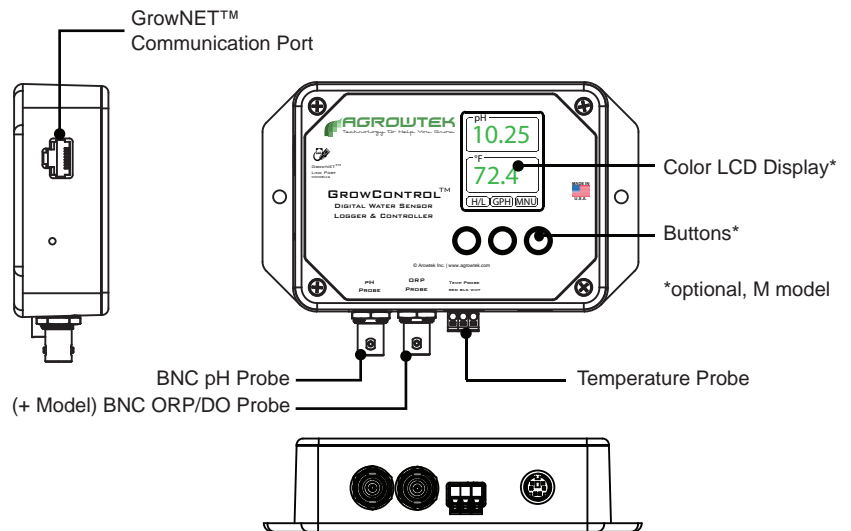
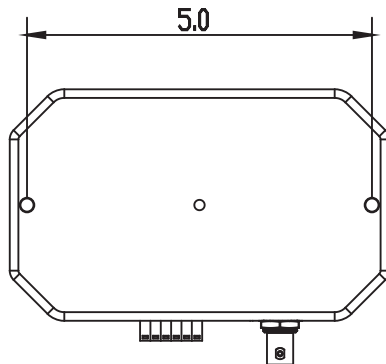

Applications



Greenhouses & Indoor Growing Facilities



Industrial Processes, PLC's



Pool & Spa



Aquarium



Analytical, Data Logging research & academic applications



OEM & custom applicatoins

GrowControl™ GCX Controller



Connect to GrowControl™ Cultivation Controllers for advanced functions as part of a complete facility control solution. GrowControl™ GCX systems feature intelligent control functions optimized for today's complex growing environments.

Mini Doser



Control up to a four-head AgrowDose ADi dosing pump with the PHX controller (also known as the MPX dosing system.) Use the intuitive menu interface to configure the target values, assign pumps and dose sizes, calibrate sensors and more. Simple and reliable system automatically maintains your pH (and ORP) levels in a reservoir.

MODBUS



GrowNET™ devices are easy to implement on PLC systems with MODBUS RTU and a LX2 ModLINK interface. Multiple GrowNET™ devices can be connected to an interface with HX8 GrowNET™ hubs.

Ordering Options

PHXM +ORP - T K

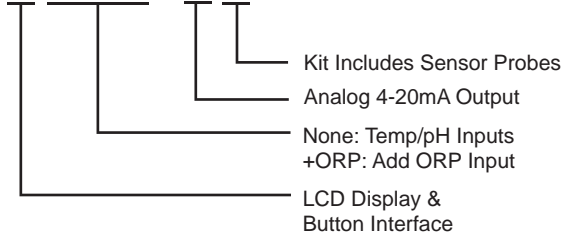

Optional Accessories

