

Mini Climate Control System



Shown with optional WiFi

Contents

Introduction	2	Setup Menu	14
Quick Start Guide	3	Time / Date	14
How Relays Work	4	Units	14
What Relays Control	4	Logging Interval	15
Installation Instructions	5	COMM Mode	15
Installing the RD8i Relay	5	Device Address	16
DC Power Connections	6	Manufacturing Info	16
Dry Contact Terminals	6	Display Back Light Timer	16
Example Connections	7	Relay Control	17
Installing the SXE Environment Sensor	8	Run/Stop	17
Connection to Intelligent Relay	8	Setup a Sensor Control	18
Operation Instructions	9	Setup a Cycle Timer	19
Definitions	9	Setup a 24-Hour Timer	19
LCD Menu Operation	10	Maintenance & Service	20
High / Low History	10	Cleaning	20
Graphing	10	Fan Filter	20
Main Menu	11	Fan Replacement	20
Alarms Menu	11	CO2 Sensor Upgrade	21
Alarms Configuration	11	Technical Information	22
Alarm Buzzer	12	Specifications	22
Calibration Menu	12	Storage and Disposal	22
Temperature or Humidity Calibration	12	Warranty	22
CO2 Calibration	13		
Clear Calibration	13		

Introduction

GrowControl MCX climate control systems are powerful, autonomous set-point controllers.

The SXE sensor connects directly to a RD8i eight-contact intelligent relay to operate up to eight devices independently. Control contacts based on temperature, humidity or CO2 values as well as an on/off cycle timer and 24-hour timer. Set points have day/night values which are selected based on the reading of the light sensor located on the top of the SXE unit.

A built-in aspirator fan provides a continuous flow of air over the sensors for the most accurate readings and fastest response to changing conditions. An air filter is included which is removable and washable.

SXE environment sensor's color display provides an easy to use interface for monitoring the sensor readings and configuring the control settings. Internal data logging memory provides a 120 point graphical history on the screen and the entire 21,600 data point history can be downloaded using the LX1 USB AgrowLINK and free computer software.

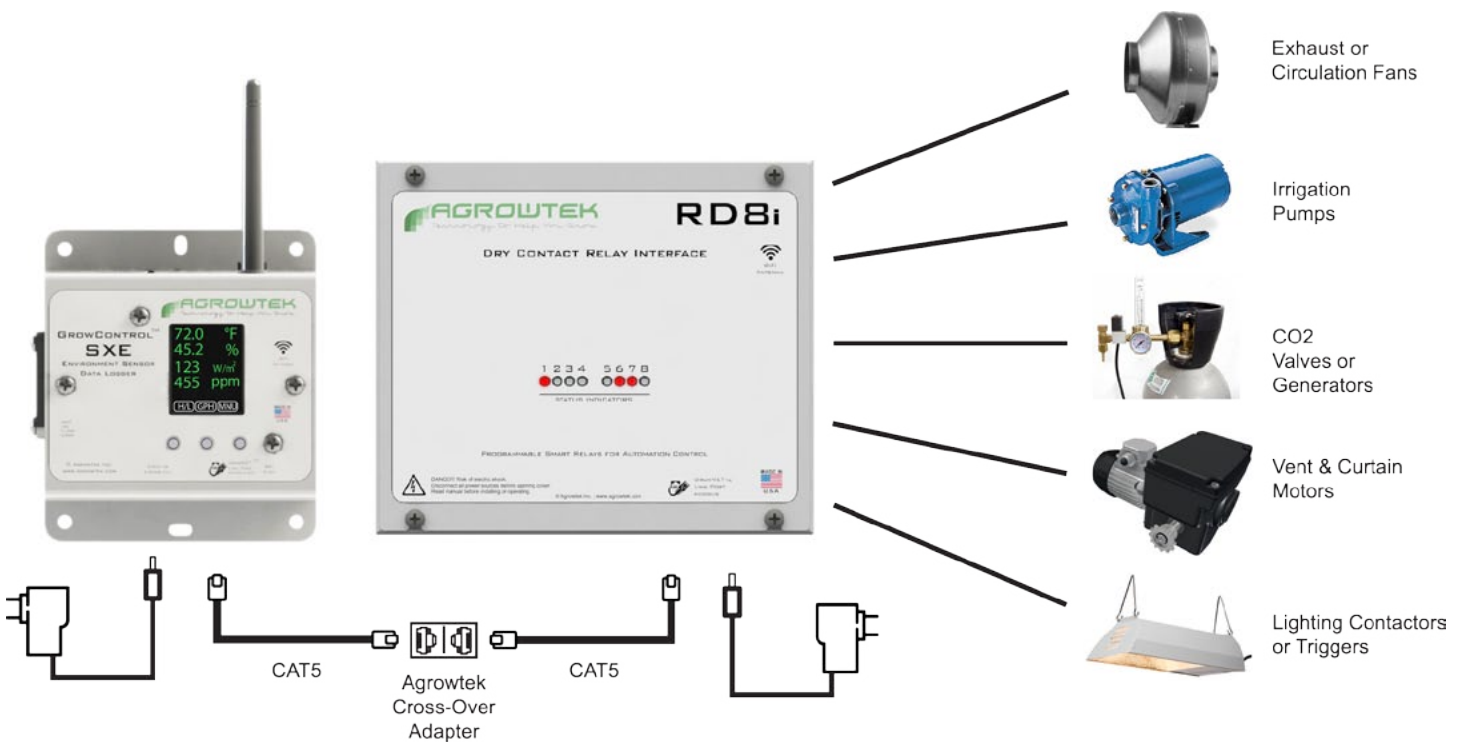

Quick Start Guide

1. Mount the Relay & Sensor

Remove the cover of the relay and use the mounting holes in the rear of the enclosure to securely mount to a wall surface near the AC power supply source. Mount the SXE climate sensor to a wall surface that is accessible and has good air circulation. *See mounting instructions.*

2. Make Connections to Relay Contact Terminals

Each of the eight relays has one pair of normally open dry contacts. Each pair of terminals is independent and does not share a common terminal. Observe ratings and code requirements.

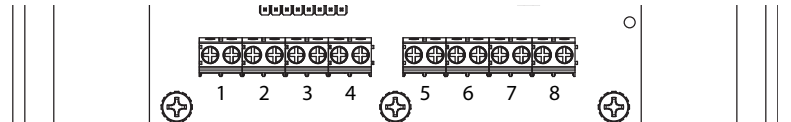

3. Connect the GrowNET Cable

Connect the sensor to the relay using the included cross-over ethernet cable as shown in the diagram.

⚠ IMPORTANT! ONLY use cross-over adapters provided by Agrowtek.
Incorrect cross-over adapters or cables can cause damage to the equipment.

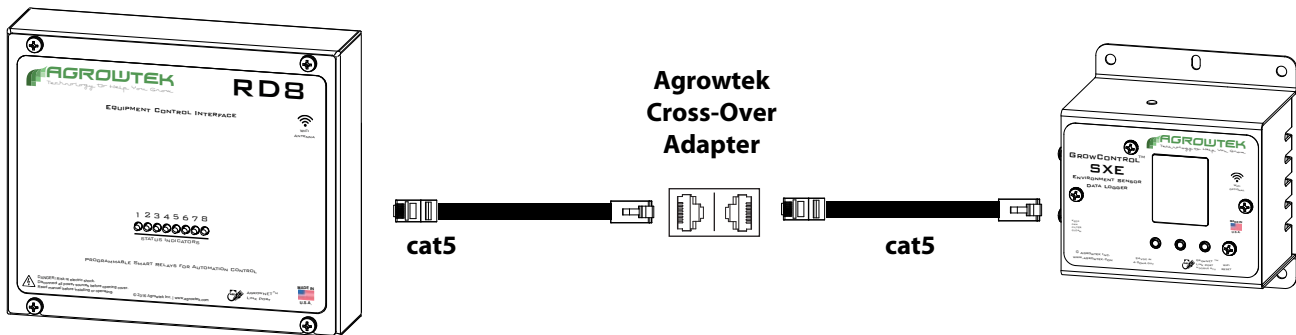

4. Connect DC Power Supplies

Plug the 24Vdc power adapters into the SXE and RD8i, and a 120Vac wall outlet. Alternatively, 12-24Vdc may be supplied to the RD8i via a terminal block inside the unit.

Follow the LCD Menu Operation instructions for details on setting up the relays to operate based on sensor readings and timers.

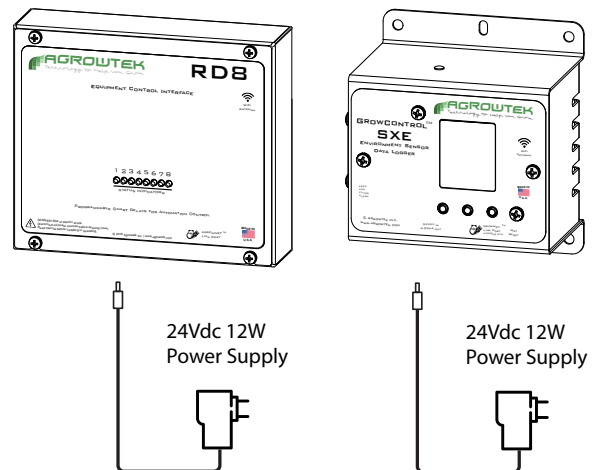

How Relays Work

A relay consists of a mechanical switch and an electro-magnet to turn-on (close) a switch contact. A spring opens the switch when the electromagnet is no longer powered.

The microprocessor controls power to the magnet coil to open or close the switch contact as required by the controller program.

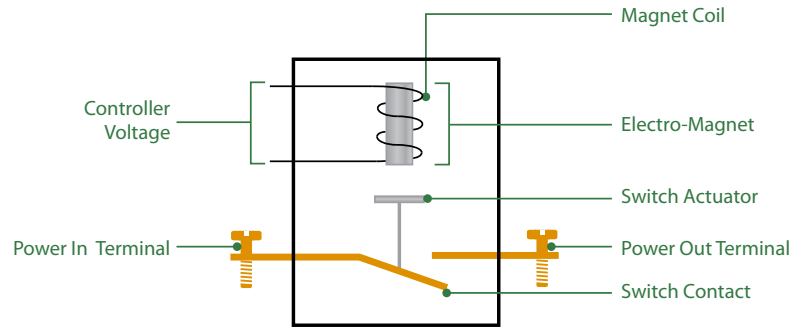

Dry-contact relays can be thought of like a wall-switch:

- Each relay “contact” has a pair of screw terminals just like a wall-switch does.
- A wall-switch (or relay contact) does not supply power, it only allows it through.
- Each switch is independent and can operate different circuits or voltages.



A dry-contact relay is exactly the same as a wall switch, however, instead of operating the switch manually with your finger, an electromagnet operates the switch.



What Relays Control

Many types of devices can be operated with a dry-contact switch. A dry-contact interface allows Agrowtek controls to integrate with building controls, high amperage loads and other custom devices such as:



High-Amp
Relays & Contactors



HVAC Control



Irrigation / Gas
Solenoids



120V Receptacles
& Equipment

Installation Instructions

General Notes:

1. Install with the connections facing down to reduce the risk of water permeating the enclosures.
2. For indoor installation only. Enclosures are not water-proof.
3. Do not place sensor in direct sunlight.

⚠️ Disconnect power from all devices before connecting or disconnecting cables to prevent damage to components.

Installing the RD8i Relay

The RD8 intelligent relay is to be installed to a vertical wall surface using the four mounting holes provided in the rear of the enclosure.

1. Remove the front cover panel using caution not to damage the LED light pipes.
2. Locate the relay box and mark the mounting hole locations or use the dimensions below.
3. Pre-drill and install anchors if necessary. Keep dust and debris away from the circuit board.

Ensure all dust and contaminants have been blown out of the enclosure.

Hardware is not provided. Drywall screws are recommended.

⚠️ Do NOT drill holes into the enclosure or enlarge holes. Metal chips from drills can cause short circuits on the PCB.

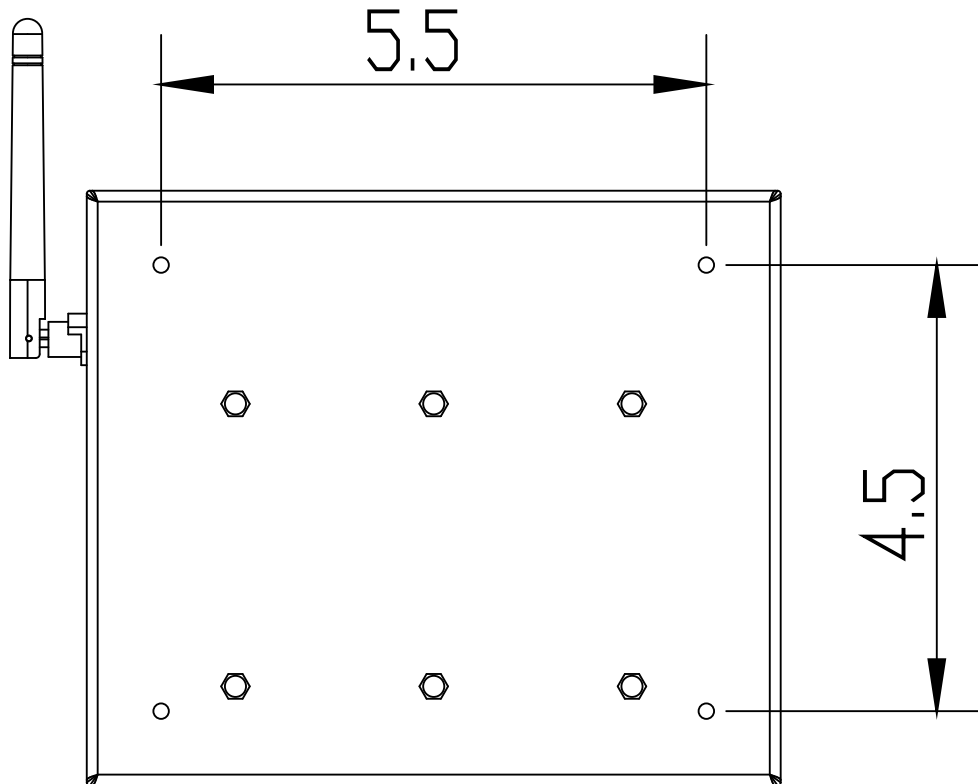

Install and wire equipment in accordance with all national and local electrical codes.

DC Power Connections

An external DC power jack and GrowNET power are located on the bottom of the relay. Standard 7/8" diameter knock-outs are provided on either side for standard 1/2" EMT conduit fittings.

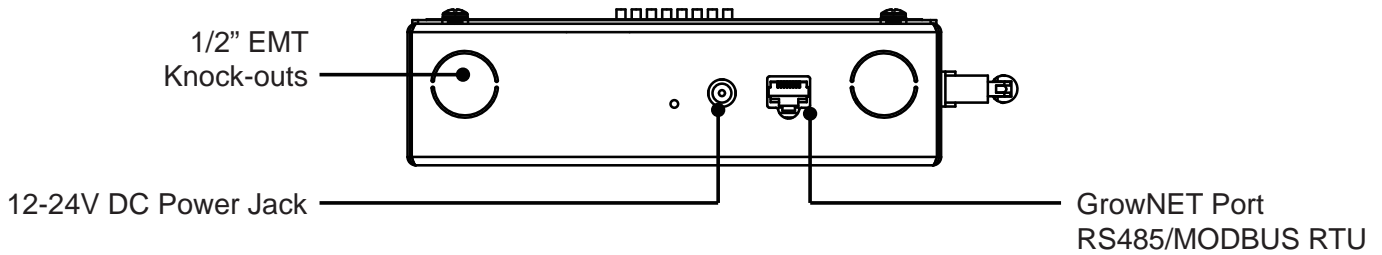

12 - 24Vdc is required to operate the RD8i which may be supplied via:

- a) the 2.1mm DC barrel jack and included power supply,
- b) the GrowNET port from an HX8 hub, or
- c) the Vin terminal block on the circuit board for DIN rail power supplies.

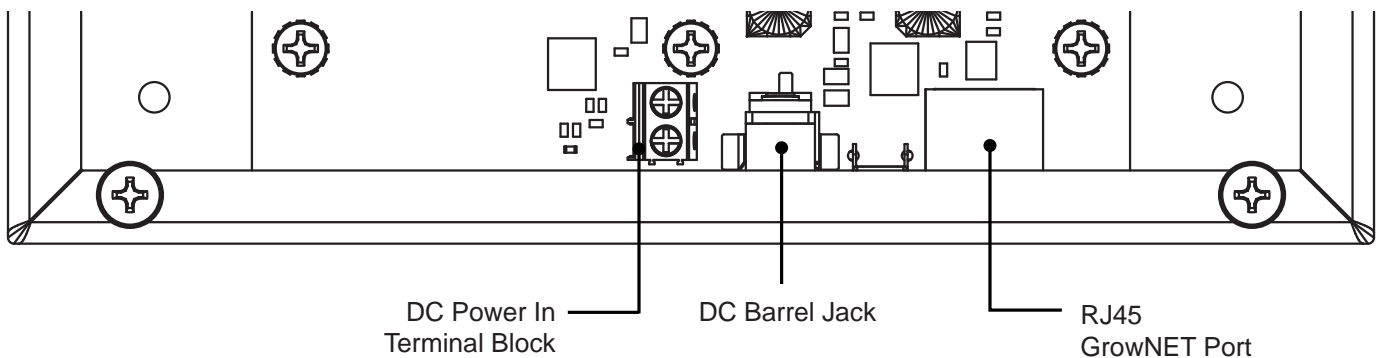

Dry Contact Terminals

Each relay has one pair of normally-open contacts which are labeled below each contact. Each relay terminal pair is independent allowing mixed signal control.

Route wires from the conduit fittings along each side of the relay pcb and above the relays to the terminal blocks as indicated by the red lines in the diagram below.

Do NOT route wires above the green terminal blocks; keep the processor area free of excess wiring.

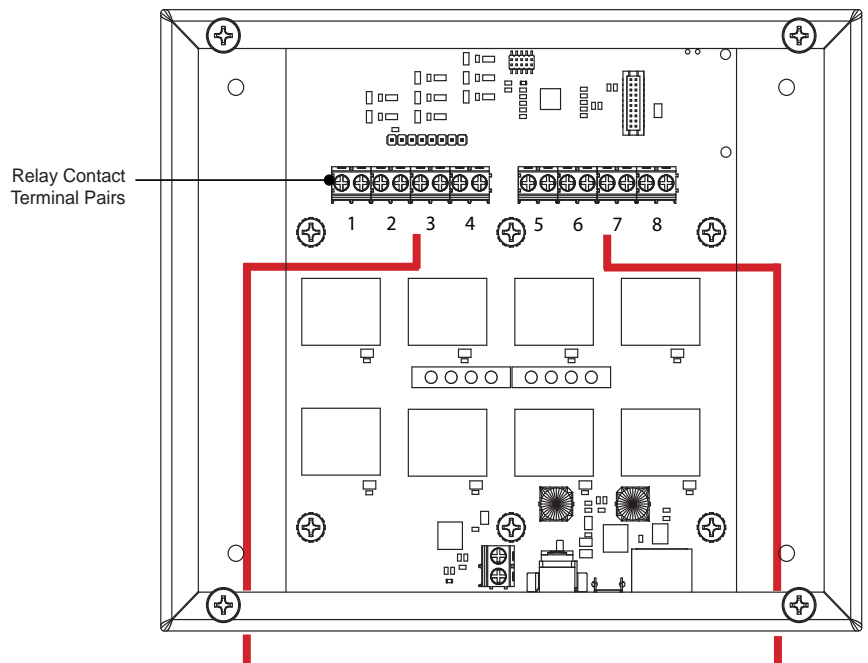

Example Connections

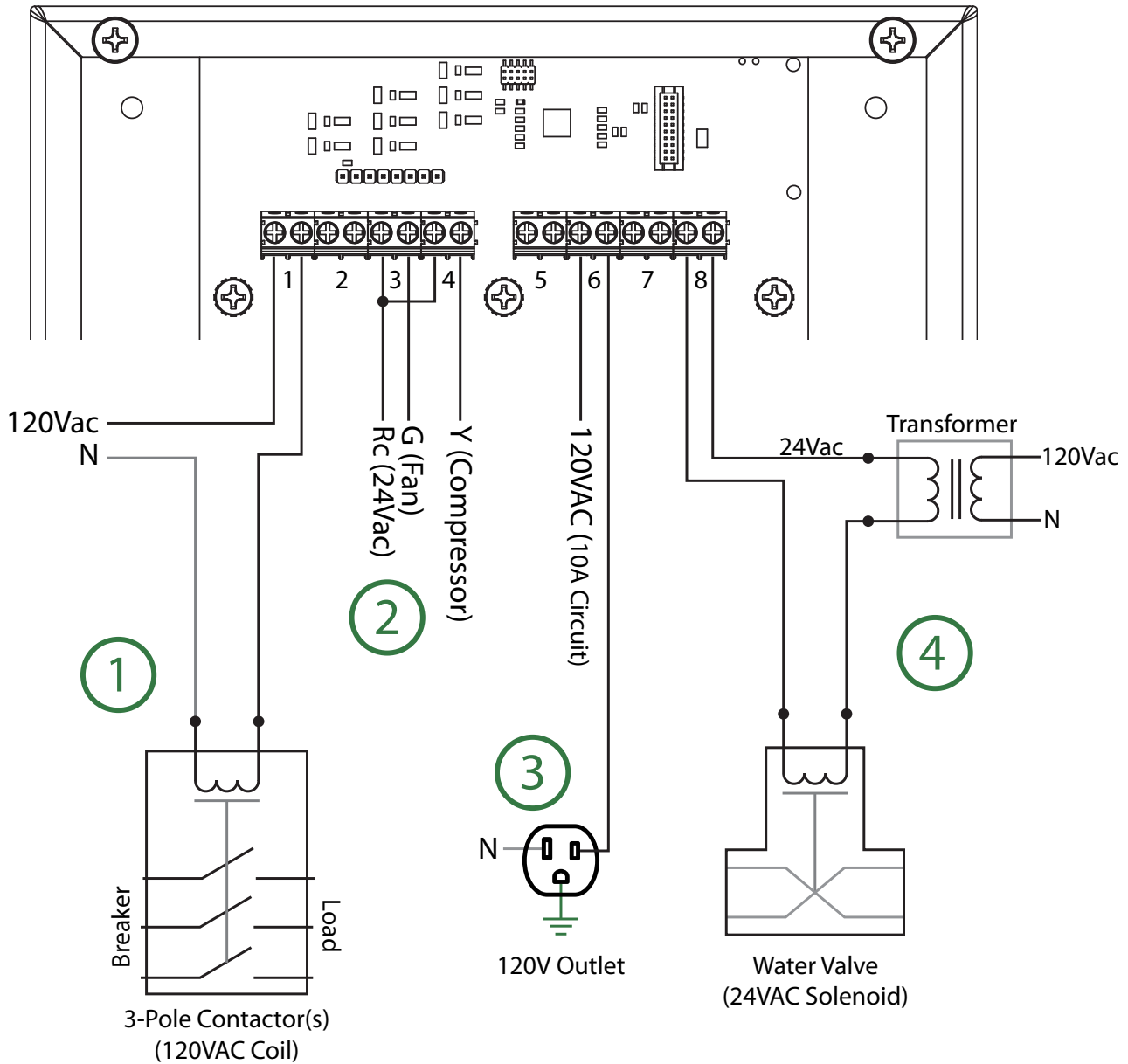

1. High-Amp Contactors

High amp contactors and relays are operated by controlling the power to the magnet coil. When the magnet is energized, high current/voltage is switched on from a breaker panel to load receptacles.

2. HVAC Control Signals

24VAC HVAC control signals may be operated by dry contact. Use jumper wires for relays with a common source connection.

3. 120V Outlets

Contacts can switch up to 10A to directly feed receptacles or other 120V equipment.

4. Solenoid Valves

24VAC irrigation and gas valves can be controlled by switching power supplied by a step-down transformer. *24VAC is safer and more common than line-voltage for water/irrigation solenoids.*

Installing the SXE Environment Sensor

SXE is intended for wall mounting near eye level using the mounting flanges and holes provided. Install in a location with adequate access to the environmental conditions and away from extreme influences such as ventilation ducts, doorways, windows or heat generating equipment such as lights and ballasts. Ensure the unit is easy to see and access for maintenance and adjustments. Do not install in direct sunlight.

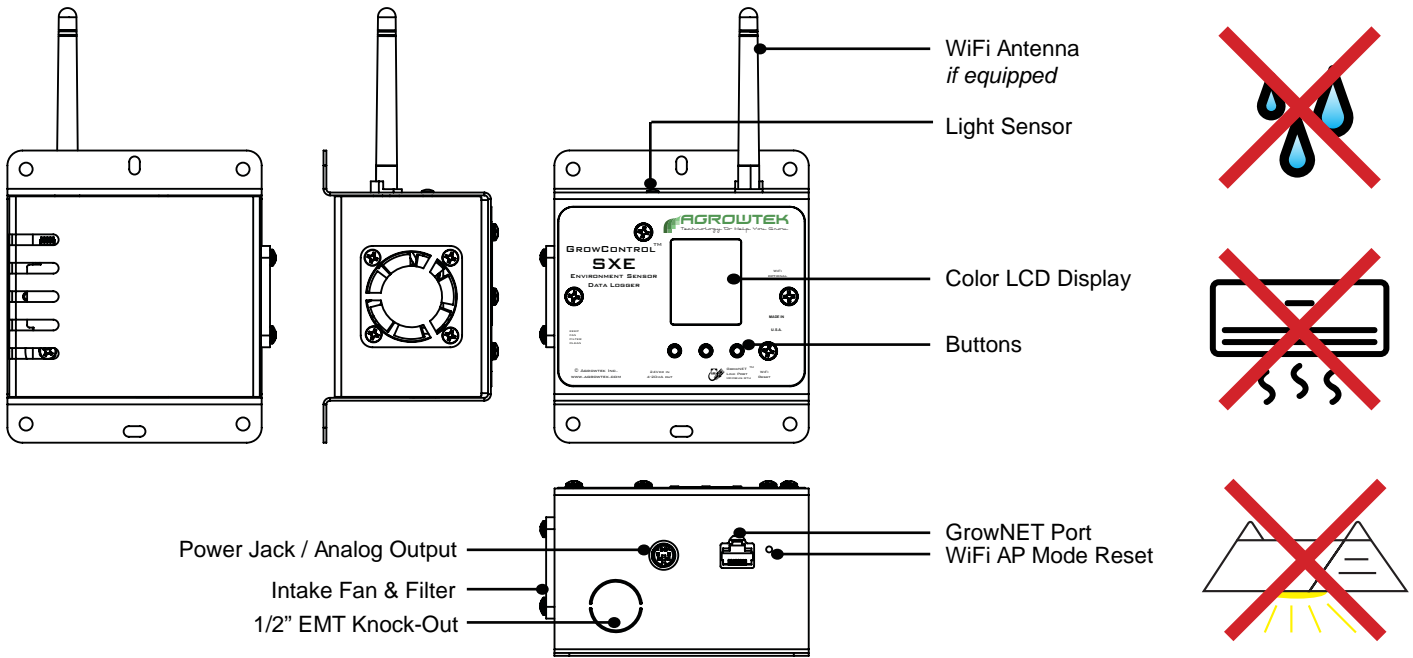

Connection to Intelligent Relay

A direct-link connection between a SXE sensor and intelligent relay requires Agrowtek's cross-over adapter.

IMPORTANT! ONLY use cross-over adapters provided by Agrowtek. Incorrect cross-over adapters or cables can cause damage to the equipment.

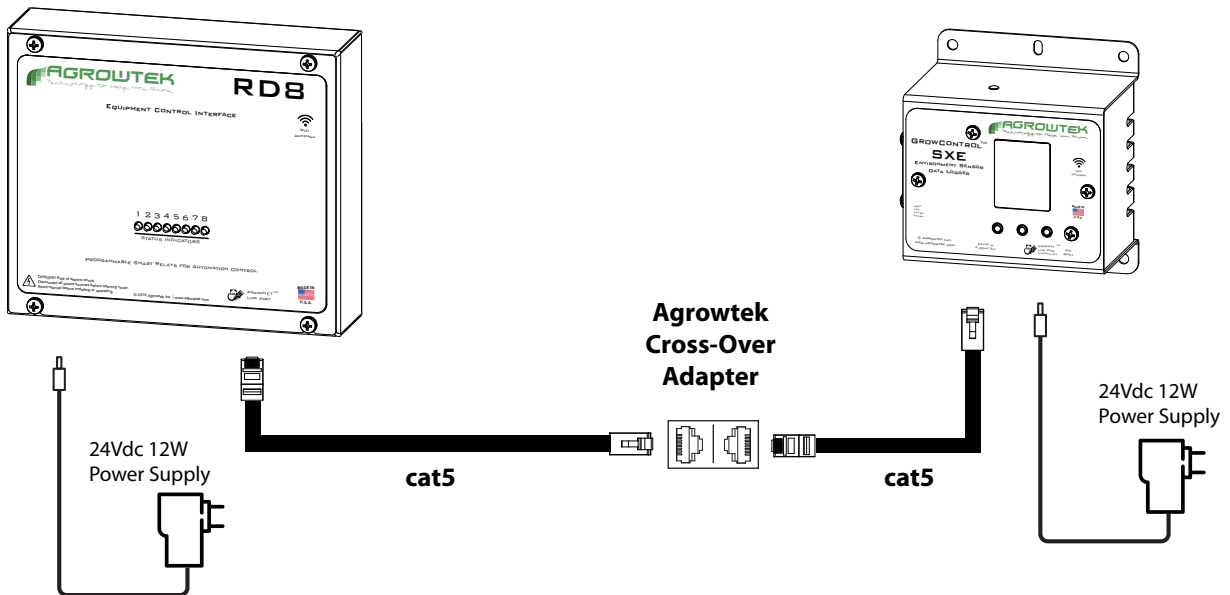

Operation Instructions

The SXE environment sensor continuously monitors the temperature, humidity and CO2 (if equipped) and a light sensor on the top of the unit detects day or night periods. Each relay contact may be assigned a temperature, humidity or CO2 control function, as well as a timer function if desired. Equipment such as heaters, fans, pumps, CO2 valves, irrigation valve, etc. can be connected to the RD8i relay for sensor based control.

Definitions

Set Point

A “set point” is what the system is looking to achieve by controlling the outlet or relay, such as maintaining a temperature of 72°F.

Dead Band

The “dead band” is the amount of drift allowed in a sensor reading before the control function activates.

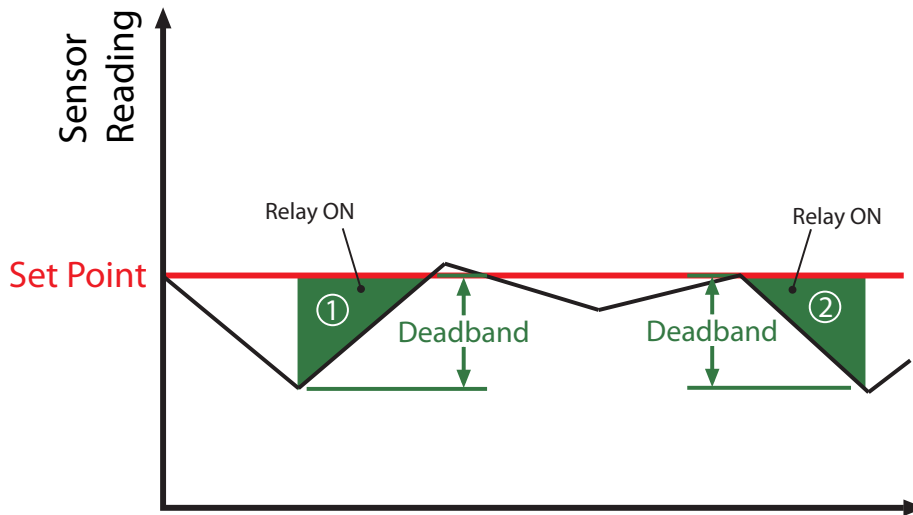

	①	②
Sensor Type		
Temperature	Heating	Cooling
Humidity	Humidify	Dehumidify
CO2	Inject	Exhaust

Mode

Sensor controls can be used in various control modes such as “HEATING” mode or “COOLING” mode. The available modes depend on the sensor type selected for the control (see chart above.)

Cycle Timer

Cycle timers operate in continuous repeating on/off cycles. Separate times are set for the on and off durations such that you may have an on or off period as short as 1 second and as long as 18 hours. Each outlet relay may be configured with a unique cycle timer.

24hr Timer

24-hour timers operate on the RTC value based on the time of day. Each timer has one on and one off time. The time is backed-up by an internal rechargeable coin cell battery backup that keeps the RTC time counting when power is off to the SXE sensor.

LCD Menu Operation

The main screen displays the real-time sensor readings from the attached sensors.

Three buttons are located beneath the screen. Each button is labeled at the bottom of the display to describe its function in the current screen or menu.

The main screen displays the real-time sensor readings from the attached sensors. Each button is labeled at the bottom of the display to describe its function on the current screen or menu.

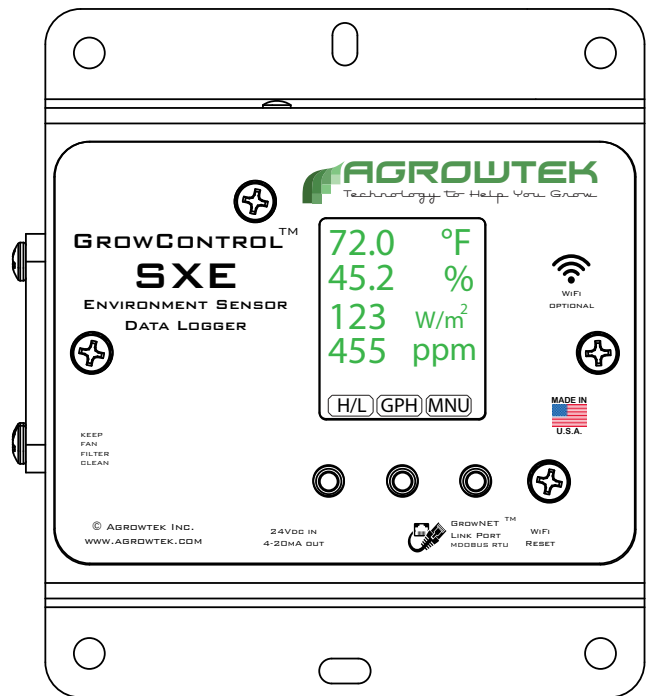

High / Low History

H/L

Simple minimum and maximum recorded values are stored until the user resets the values to the current readings. To view the minimum and maximum values since the last reset, press the button labeled **H/L**.

To clear the min/max history, press the **RST** button to reset. The min and max values will all be set to the current readings and will update with higher or lower readings as they occur.

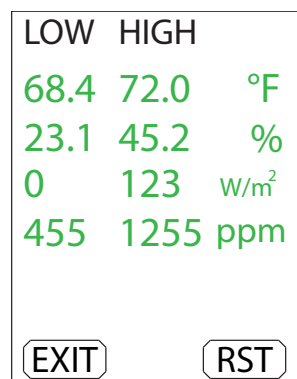

Graphing

GPH

The display can graph the most recent 120 data points from the sensor's internal data point memory. With the default logging interval of 60 seconds, the graph displays the last two hours of data.

The sensor value is plotted in green. Temperature, if overlaid on the plot, is red. Alarm levels as set by the user are plotted in yellow. Pressing the **RFH** button refreshes the data and replots the graph.

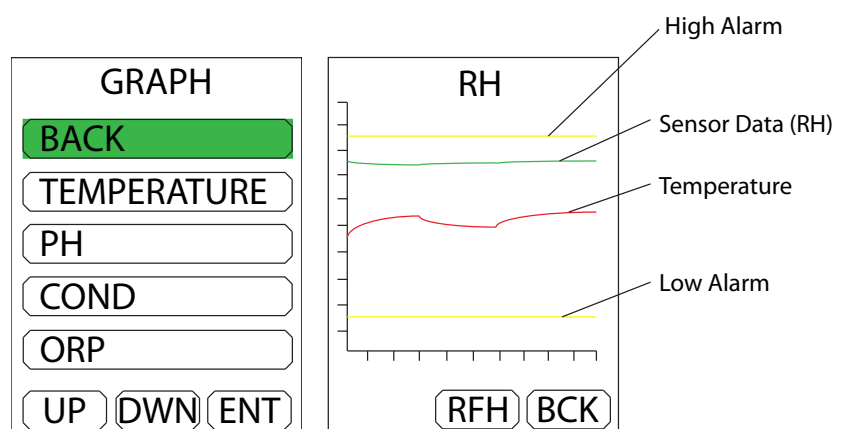

Main Menu

MNU

The main menu is how the alarms are set, sensors are calibrated and general settings such as time, date and units are configured.

If a dosing pump is directly connected to the SXHM GrowNET port, the pump settings are also accessed by the main menu.

Use the **UP** or **DWN** buttons to navigate the menu.

Use the **ENT** button to enter a selection.

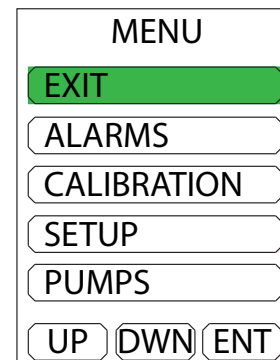

Alarms Menu

MNU ► ALARMS

High and low alarm set points may be configured for each sensor value to activate an internal buzzer or send alerts with the optional wifi module.

The out-of-range value will be displayed in **red** to indicate the cause for the alarm.

Additionally, alarm limits are plotted on the graphs to indicate values are within the desired range.

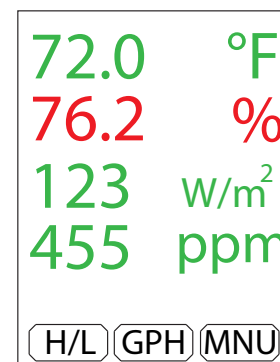

Alarms Configuration

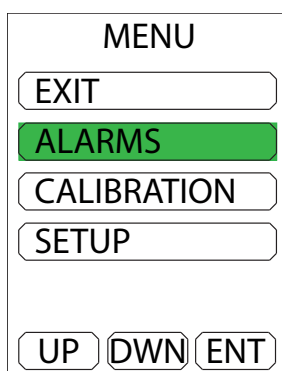

1. Select **ALARMS** from the main menu.

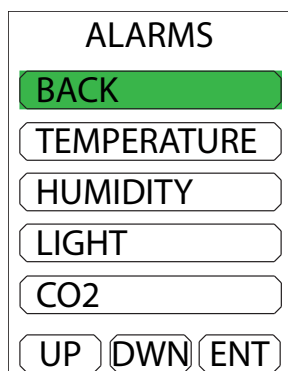

2. Select a sensor to configure set points.

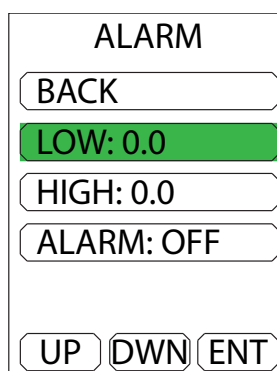

3. Select the setting to adjust.

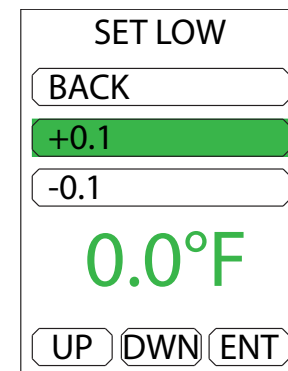

4. Adjust to the desired value. Hold **UP** or **DWN** to jog the value.

Alarm Buzzer

ALARM

BACK

LOW: 0.0

HIGH: 0.0

ALARM: OFF

UP DWN ENT

1. Select **ALARM: OFF**

SET ALARM

BACK

SET ON

SET OFF

OFF

UP DWN ENT

2. Select **SET ON** then press **BACK** to exit.

To disable the alarm buzzer, set the alarm to OFF.

Calibration Menu

MNU > CALIBRATION

Calibration can be performed for each sensor with the LCD interface using either standard calibration wizards, or advanced manual calibration methods for non-standard calibration solutions.

The date of the last calibration for each sensor is stored in memory and displayed at the start of each calibration wizard.

MENU

EXIT

ALARMS

CALIBRATION

SETUP

UP DWN ENT

CALIBRATION

BACK

TEMPERATURE

HUMIDITY

CO2

CLEAR ALL

UP DWN ENT

Temperature or Humidity Calibration

MNU > CALIBRATION > TEMPERATURE

CALIBRATION

BACK

CALIBRATE

ADVANCED

UP DWN ENT

1. Select **CALIBRATE** from the temperature calibration menu.

TEMPERATURE

LAST CALIBRATION
10/19/2017

PRESS NEXT TO
ADJUST
TEMPERATURE
READING.

EXIT NEXT

2. Press **NEXT** to continue.

OFFSET

BACK

+0.1

-0.1

72.2°F

UP DWN ENT

3. Adjust to the desired value. Hold **ENT** to jog the value by 10x.

CONFIRM?

OLD
68.1 °F

NEW
72.2 °F

YES NO

4. Confirm the new reading or press **NO** to cancel.

CO2 Calibration

MNU ► CALIBRATION ► TEMPERATURE

CALIBRATION

BACK

CALIBRATE

ADVANCED

UP DWN ENT

1. Select **CALIBRATE** from the temperature calibration menu.

CO2

LAST CALIBRATION
10/19/2017

PUT SENSOR IN
OUTDOOR AIR.

EXIT NEXT

2. Press **NEXT** to continue.

CO2

389 ppm

WAIT FOR READING
TO STABILIZE THEN
PRESS DONE.

EXIT DNE

3. Wait 5-10 minutes and allow reading to normalize. Then press done to complete the calibration.

 **Keep away from the sensor during normalization (step 3) and press the done button upon approaching the sensor to avoid disturbing the calibration. Do not breathe near the sensor or locate near individuals, vehicles or other sources of carbon dioxide during calibration.**

Clear Calibration

MNU ► CALIBRATION ► NEXT

Calibration can be restored to factory defaults by selecting **CLEAR ALL**.

CALIBRATION

BACK

TEMPERATURE

PH

COND

CLEAR ALL

UP DWN ENT

1. Select **CLEAR ALL** from the calibration menu.

RESTORE TO
FACTORY
CALIBRATION?

YES NO

2. Press **YES** to restore factory calibration.

Setup Menu

MNU ► SETUP

The setup menu is where the time and date are set, the units are configured, logging interval is adjusted and advanced communications settings are available.

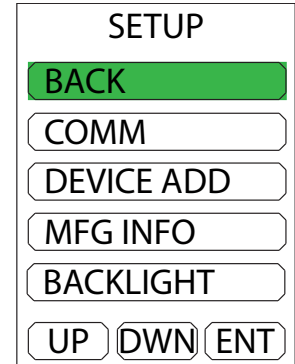
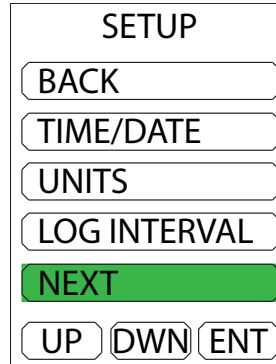

Time / Date

MNU ► SETUP ► TIME/DATE

Sensors include a precision real-time clock with battery back-up for time-stamping the data log information with the time and date. The last calibration for each sensor is also time stamped.

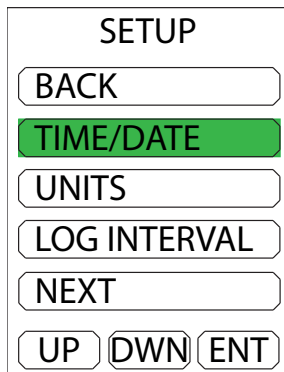

1. Select **TIME/DATE** from the setup menu.

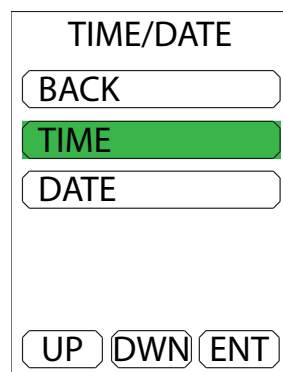

2. Select **TIME** or **DATE** to adjust.

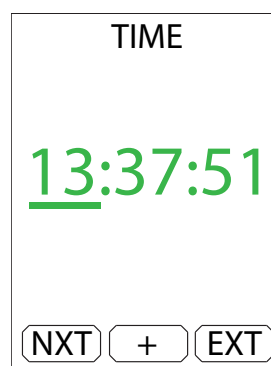

3. Use **NXT** to select the value to adjust. Use **+** to increment the value.



4. Use **EXT** to exit the menu.

Units

MNU ► SETUP ► UNITS

Temperature and Conductivity may be displayed in alternate units.

Select a sensor value to change the default display and working units.

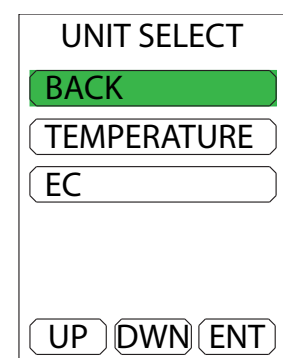
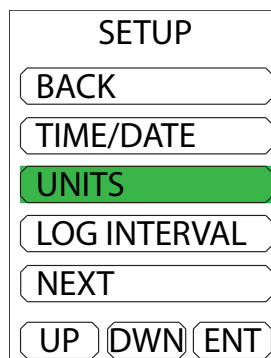

Configure temperature units:

Temperature may be displayed in °F or °C.

Note: Check alarm settings when converting temperature units.

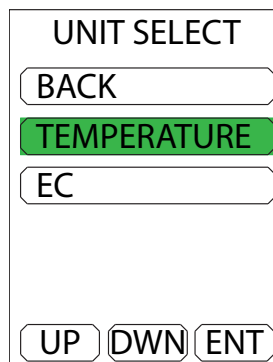

1. Select **TEMPERATURE** from the units menu.

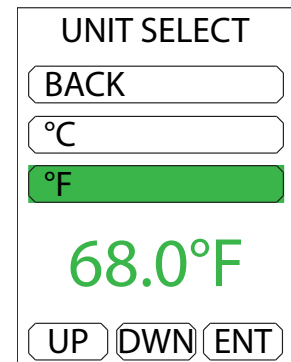

2. Select the desired units and press **ENT**.

Logging Interval



Adjust the interval for recording data points in the on-board memory. Acceptable values are from 1 - 65535 seconds.

21,600 data points can be stored for each sensor value. The most recent 120 data points are shown on the graphical history.

The entire data history may be downloaded from the sensor to a .csv file with the LX1 USB AgrowLINK and free software.

Note: 60 second intervals = 15 days of data storage.

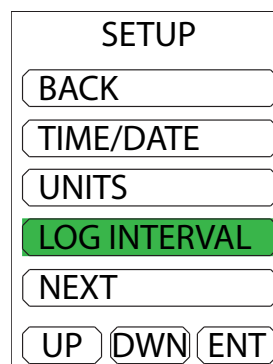

1. Select **LOG INTERVAL** from the setup menu.

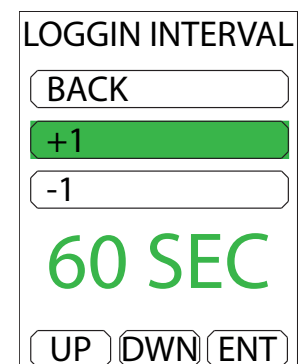

2. Adjust the value then select **BACK**.

COMM Mode



COMM mode specifies whether the sensor is a normal passive device or "mini-master" device.

NORMAL Use with GrowControl master controller systems or stand-alone and data logging applications.

MINI-MASTER Use with MCX mini-climate control system. (GrowNET cross-over adapter required.)

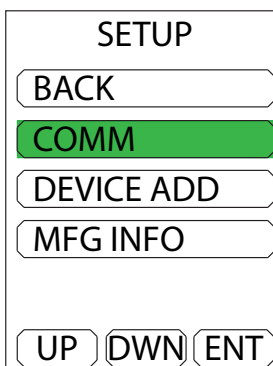

1. Select **COMM** from the setup menu.

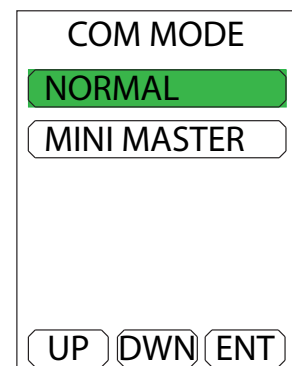

2. Select a mode and press **ENT**.

Device Address

MNU ► SETUP ► NEXT ► DEVICE ADD

Sensors are digitally addressable from 1-249 and will be assigned an address automatically by Agrowtek's control systems, or can be configured manually for MODBUS applications via the menu.

NOTE: All of Agrowtek's devices use address 254 as a broadcast address.



NOTE: Address must be set to 0 for Relay control. The "RELAY" menu item will not appear unless the device address is set to 0.

SETUP		
BACK		
COMM		
DEVICE ADD		
MFG INFO		
BACKLIGHT		
UP	DWN	ENT

1. Select **DEVICE ADD** from the setup menu.

DEVICE ADDRESS		
BACK		
+1		
-1		
0 Addr		
UP	DWN	ENT

2. Adjust the value then select **BACK**.

Manufacturing Info

MNU ► SETUP ► NEXT ► MFG INFO

Manufacturer information such as serial number, date of manufacture, hardware and firmware versions can be read from the MFG INFO page.

SETUP		
BACK		
COMM		
DEVICE ADD		
MFG INFO		
BACKLIGHT		
UP	DWN	ENT

SERIAL NUMBER: 17090554		
DATE OF MFG: 09/15/17		
HW VERSION: C		
FW VERSION: 02.03.84		
EXIT		

Display Back Light Timer

MNU ► SETUP ► NEXT ► BACKLIGHT

The display back light can be programmed to turn off after a specified time of inactivity from the last time a button is pressed.

The delay can be set from 1-255 minutes, or set to 0 to disable the back light timer and keep the display on continuously.

SETUP		
BACK		
COMM		
DEVICE ADD		
MFG INFO		
BACKLIGHT		
UP	DWN	ENT

BACKLIGHT		
BACK		
+1		
-1		
60 Min		
UP	DWN	ENT

Relay Control

MNU ► RELAYS

The RELAYS menu is displayed when the environment sensor is connected to a relay and contains all of the configuration settings pages.

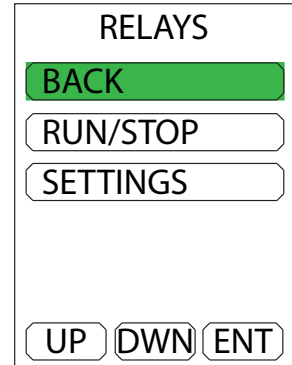
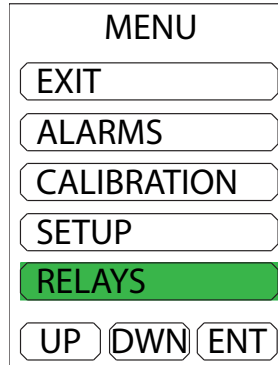

 The "RELAYS menu item will not appear unless the communication mode is set to "MINI-MASTER" and the device address is set to "0" (see COMM MODE and DEVICE ADDRESS.)

Run/Stop

MNU ► RELAYS ► RUN/STOP

The relay device must be placed into RUN mode for autonomous operation to take place.

All of the relays may be immediately disabled and turned off by placing the relay device into STOP mode.

The relay will operate according to the programmed parameters unless the relay is put into STOP mode or the sensor becomes disconnected from the relay after 10 seconds. If in RUN mode, the relay will continue operating after a power outage when the power is restored.

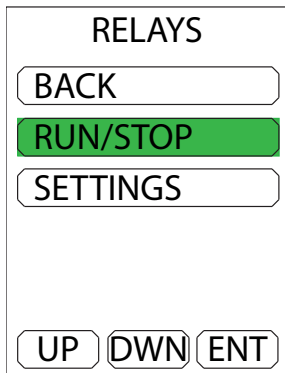

The RUN/STOP menu enables or disables the pumps

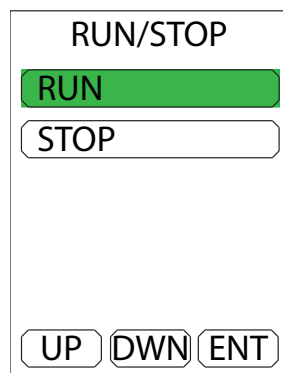

Select **RUN** to allow the relays to operate based on your settings.

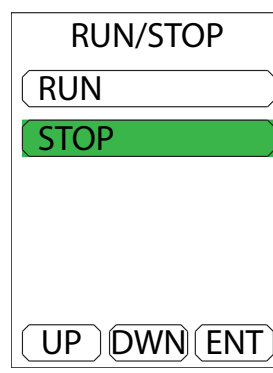

Select **STOP** to disable the relays from running automatically and turn off all relays.

Setup a Sensor Control

MNU ► RELAYS ► SETTINGS

Each relay may be configured for set-point operation based on a sensor value (see “Definitions” section for details.) When light sensor reading = 0 W/m², it is considered **night**.



1. Select **SETTINGS** from the relays menu.

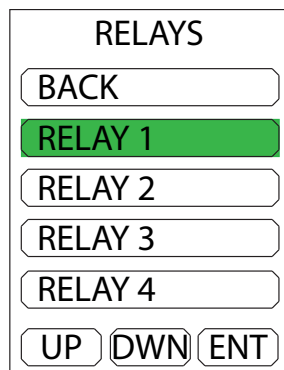

2. Select a relay to configure.

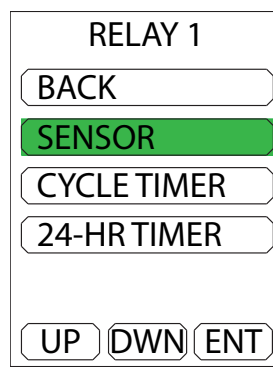

3. Select **SENSOR** to setup a sensor control.

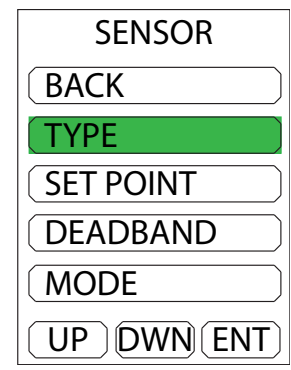

4. Select **TYPE** to choose the sensor type.

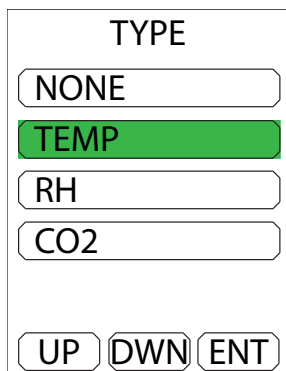

5. Select the desired sensor type.

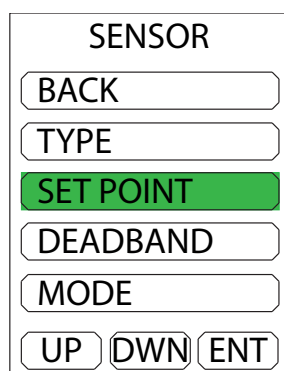

6. Select **SET POINT**.

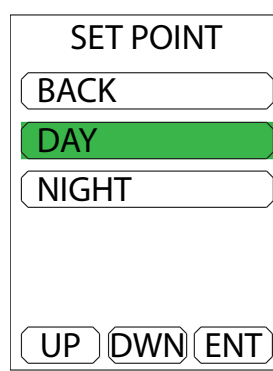

7. Select **DAY** or **NIGHT** to adjust the settings. Enter values for both.

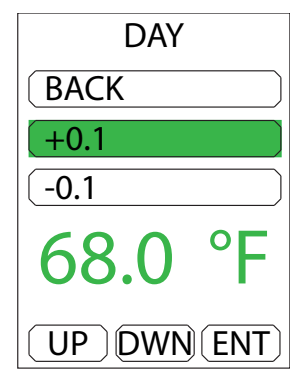

8. Adjust the set points to the desired values.

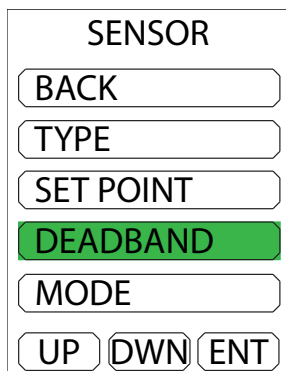

9. Select **DEADBAND** to configure the sensitivity of the control.

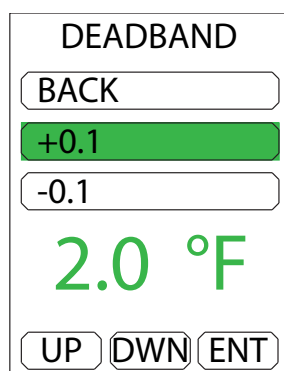

6. Set the deadband to the desired value.

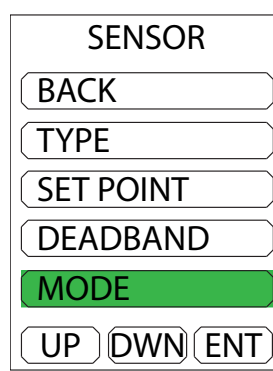

11. Select **MODE** to define the control mode for the sensor.

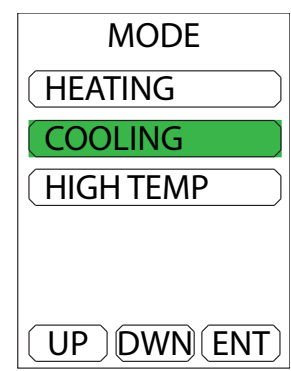

12. Set the desired control mode.

Setup a Cycle Timer

MNU ► RELAYS ► SETTINGS

Each relay may be controlled by a “repeat cycle timer” which will turn on the relay for a set time, then off for a set time in a continuously repeating cycle. If a sensor control or 24-hour timer are also configured on the same relay number, they may activate the relay even during the cycle timer’s ‘off’ period.

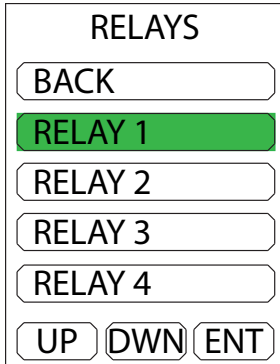

RELAYS

BACK

RELAY 1

RELAY 2

RELAY 3

RELAY 4

UP DWN ENT

1. Select a relay to configure.

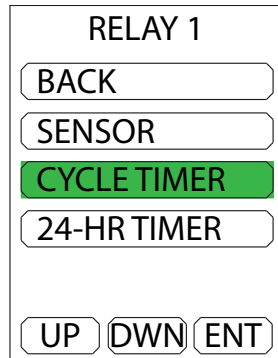

RELAY 1

BACK

SENSOR

CYCLE TIMER

24-HR TIMER

UP DWN ENT

2. Select **CYCLE TIMER** to setup a timer control.

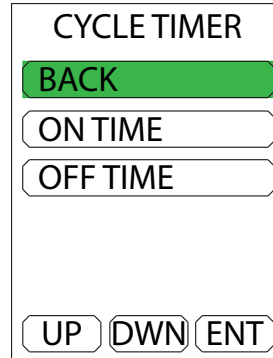

CYCLE TIMER

BACK

ON TIME

OFF TIME

UP DWN ENT

3. Select **ON** or **OFF** to edit the timer values.

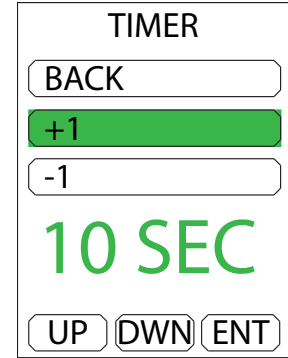

TIMER

BACK

+1

-1

10 SEC

UP DWN ENT

4. Adjust the times to the desired values.

Setup a 24-Hour Timer

MNU ► RELAYS ► SETTINGS

Each relay may be controlled by a “24-hour timer” which will turn the relay on at a set time of day, and off at a later time of day. If a sensor control or cycle timer are also configured on the same relay number, they may activate the relay even during the 24-hour timer’s ‘off’ period.

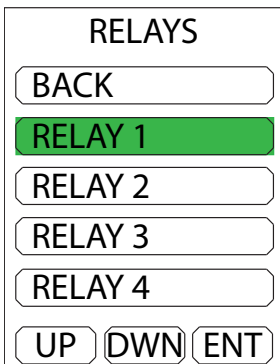

RELAYS

BACK

RELAY 1

RELAY 2

RELAY 3

RELAY 4

UP DWN ENT

1. Select a relay to configure.

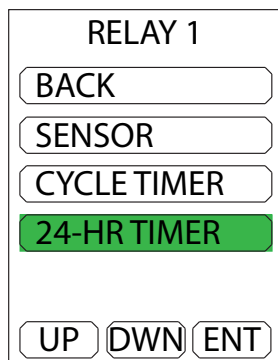

RELAY 1

BACK

SENSOR

CYCLE TIMER

24-HR TIMER

UP DWN ENT

2. Select **24-HR TIMER** to setup a timer control.

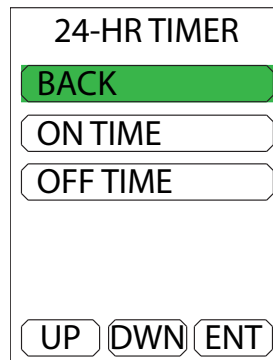

24-HR TIMER

BACK

ON TIME

OFF TIME

UP DWN ENT

3. Select **ON** or **OFF** to edit the timer values.

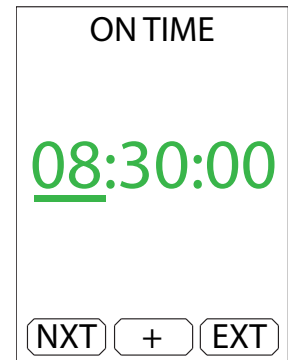

ON TIME

08:30:00

NXT + EXT

4. Adjust the times to the desired values.

Maintenance & Service

Sensors require periodic maintenance to ensure proper performance. Relays do not require maintenance.

Cleaning

Exterior and label surfaces may be wiped with a damp cloth with mild dish detergent, then wiped dry.

Fan Filter

The fan air filter should be periodically removed for cleaning. **It is NOT necessary to remove the fan.**

1. Pry the retaining grate out using a small flat blade eye-glass screwdriver or tip of a pocket knife.
2. Remove the foam filter and replace, or clean with mild dish detergent and water, then pat dry.
3. Re-install the foam filter and grate by gently snapping the grate back into place.

Fan Replacement

The fan may require replacement in the event of failure.

1. Disconnect power from the sensor and un-mount from the wall.
2. Remove the rear cover by removing the two screws marked (1).
3. Remove the four screws and nuts securing the fan and filter assembly to the housing.
4. Disconnect the fan wires from the terminal block and install the new fan leads to match.
5. Clean and re-install the fan filter on the outside, and the new fan on the inside of the rear cover.
6. Hand tighten the four fan screws and re-install the rear cover using the two cover screws.

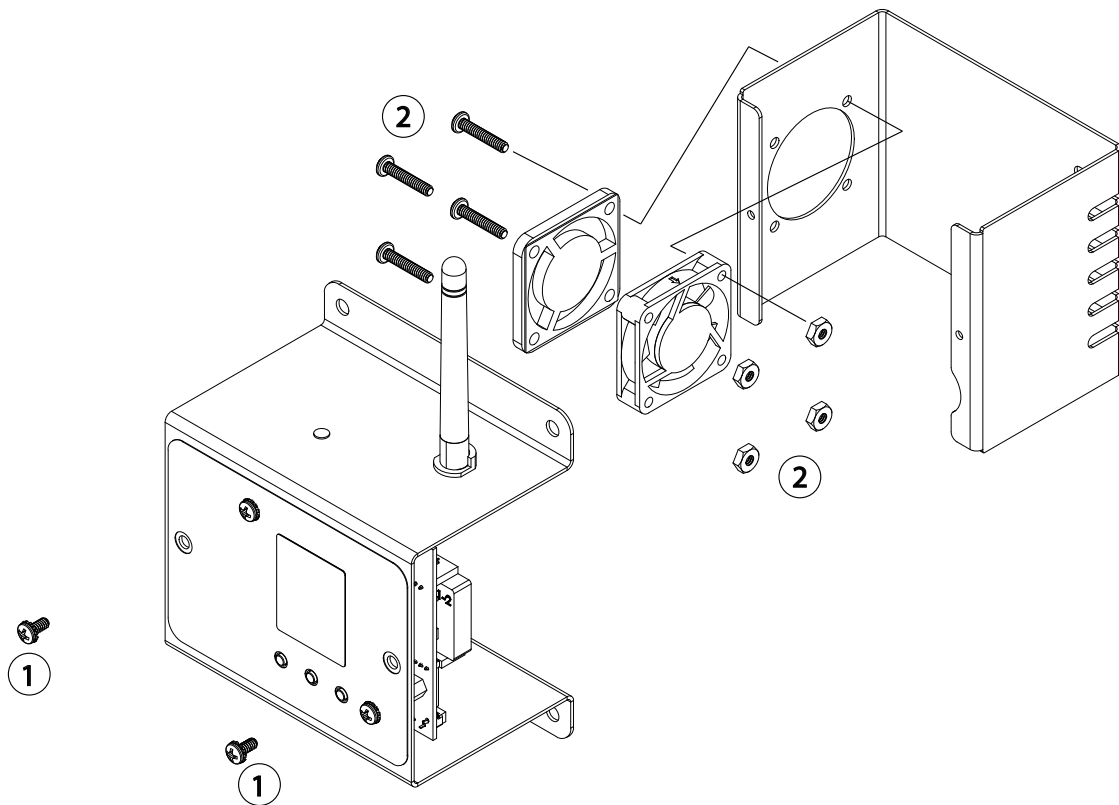

CO2 Sensor Upgrade

The SXE sensor may be upgrade to sense and control CO2 ppm with a precision NDIR type CO2 sensor.

1. Disconnect power from the sensor.
2. Remove the rear cover by removing the two screws; use caution not to damage the fan wires.
3. Locate the CO2 headers.
4. Position and install the CO2 sensor module ensuring the sensor is oriented with the correct pin headers.
5. Re-install the rear cover and re-connect power. Check to ensure the CO2 reading is now working.

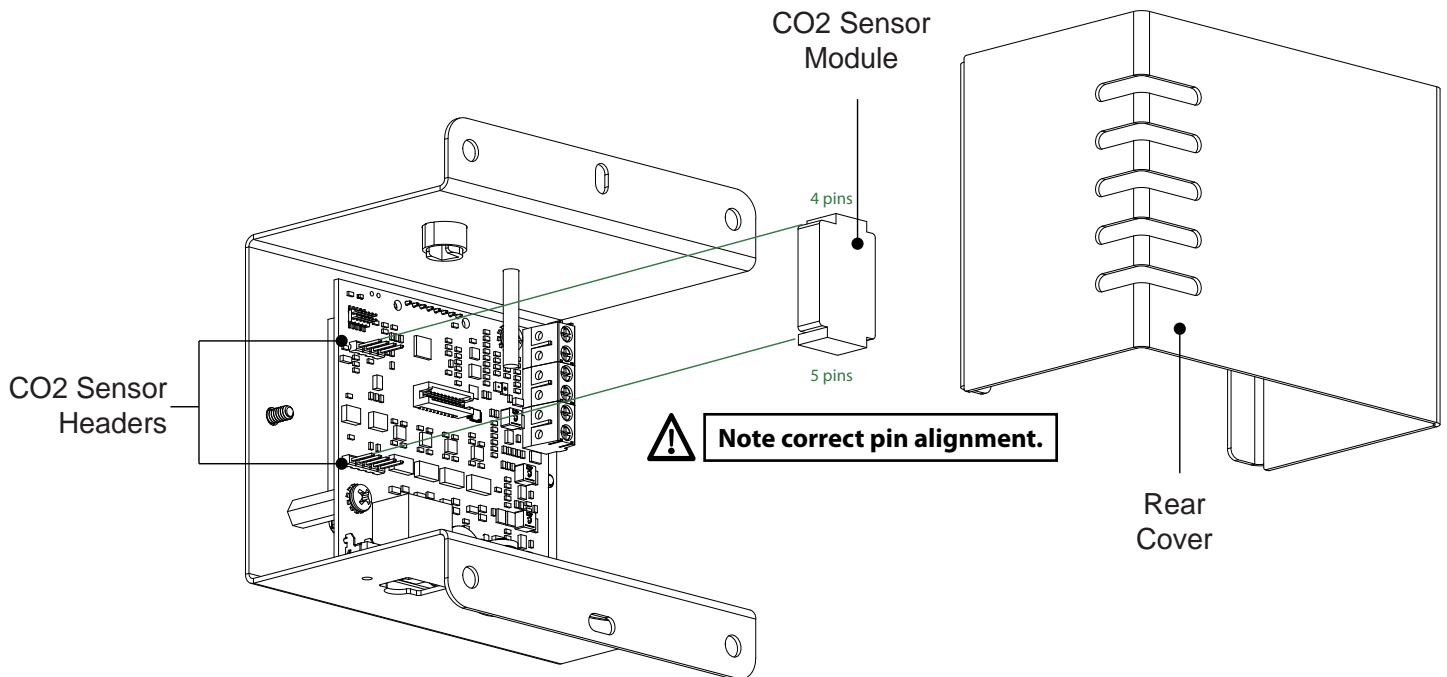

Technical Information

Specifications

Sensor Specifications

Power	24Vdc, ~5W
Max Cable Distance	1000ft
Aspirator	6cfm Fan with Foam Filter
Temperature Range	-20 - 60°C
Temperature Accuracy	±2°C
Humidity Range	0-100%RH (non condensing)
Humidity Accuracy	±3%
Light Irradiance Range	0 - 1000W/m2
Light Accuracy	±10%
CO2 Range	0-10,000ppm
CO2 Accuracy	±100ppm
4-20mA DAC Resolution	12 bit, 0.005mA

Relay Specifications

Input Power	12-24Vdc
Max Switching Current	10A per point
Max Switching Voltage	120Vac
Independent Contacts	8x Normally Open
Status Indicators	Red LEDs
Enclosure Knock-Outs	(2) dia. 7/8"
Enclosure Rating	IP40
Minimum Cycle Time	1 second
Interface	RS485 with MODBUS or WiFi
Relay Ratings	1,000,000 cycles
Relay Cycle Counters	Up to 4 billion cycles per relay

Storage and Disposal

Storage

Store equipment in a clean, dry environment with ambient temperature between 10-50°C.

Disposal

This industrial control equipment may contain traces of lead or other metals and environmental contaminants and must not be discarded as unsorted municipal waste, but must be collected separately for the purpose of treatment, recovery and environmentally sound disposal. Wash hands after handling internal components or PCB's.

Warranty

Agrowtek Inc. warrants that all manufactured products are, to the best of its knowledge, free of defective material and workmanship and warrants this product for 1 year from the date of purchase. This warranty is extended to the original purchaser from the date of receipt. This warranty does not cover damages from abuse, accidental breakage, or units that have been modified, altered, or installed in a manner other than that which is specified in the installation instructions. Agrowtek Inc. must be contacted prior to return shipment for a return authorization. No returns will be accepted without a return authorization. This warranty is applicable only to products that have been properly stored, installed, and maintained per the installation and operation manual and used for their intended purpose. This limited warranty does not cover products installed in or operated under unusual conditions or environments including, but not limited to, high humidity or high temperature conditions. The products which have been claimed and comply with the aforementioned restrictions shall be replaced or repaired at the sole discretion of the Agrowtek Inc. at no charge. This warranty is provided in lieu of all other warranty provisions, express or implied. It is including but not limited to any implied warranty of fitness or merchantability for a particular purpose and is limited to the Warranty Period. In no event or circumstance shall Agrowtek Inc. be liable to any third party or the claimant for damages in excess of the price paid for the product, or for any loss of use, inconvenience, commercial loss, loss of time, lost profits or savings or any other incidental, consequential or special damages arising out of the use of, or inability to use, the product. This disclaimer is made to the fullest extent allowed by law or regulation and is specifically made to specify that the liability of Agrowtek Inc. under this limited warranty, or any claimed extension thereof, shall be to replace or repair the Product or refund the price paid for the Product.